

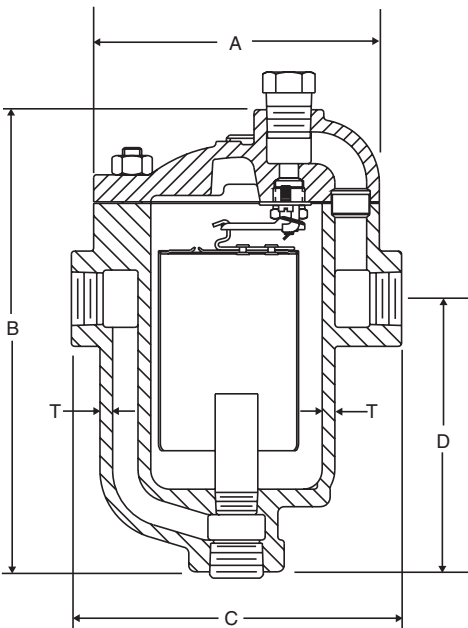


# SERVICE GUIDE

---

## Armstrong Inverted Bucket Steam Traps

---



# Table of Contents

Trap Priming _____	2
Installation _____	3-8
Testing _____	9-10
Inspection & Repair _____	10-14
Trouble Shooting _____	14-18
Optional Accessories _____	18-20
Trap Repairs & Change of Operating Pressure	20-22
Ordering Repair Parts _____	23
Parts Identification _____	24
Orifices & Valves _____	24-25
Mechanisms _____	25
Buckets _____	26
Bodies, Caps, Gaskets _____	27
Inlet Tubes _____	28
Definitions _____	29
Steam Tables _____	30-31
Flash Steam _____	31-32
Schedule 40 Pipe Dimensions _____	33
Recommendations _____	34
Trap Application Assistance _____	36

## Trap Priming

All Inverted Bucket Steam Traps are basically self-priming on initial start-up and should require no further priming. Normally, on a cold start-up of the equipment being trapped, enough condensate reaches the steam trap body to create the necessary water seal (prime) before steam reaches it.

Failure to establish this water seal prime results in live steam loss through the trap. In the rare instance that the trap fails to initially prime itself turn the steam off to the trap, wait 5 minutes and then turn the steam **slowly** back on. Condensate will collect behind the closed valve during the shut-off period. Slowly opening this valve will assure that condensate reaches the trap body before steam, thus priming the steam trap. **All inverted bucket air traps must be primed before starting.**

Designs and materials are subject to change without notice.

# Installation of Inverted Bucket Traps

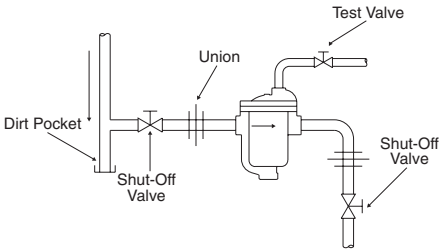
## Before Installing

Run pipe to trap. Before installing the trap, clean the line by blowing down at full steam pressure. (Clean any strainer screens after this blow-down.)

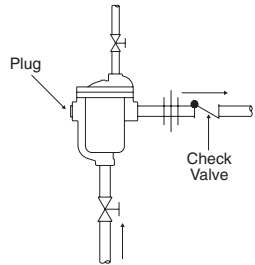
## Trap Location

1. Make the trap easily accessible for inspection and repair.
2. Install the trap below the drip point whenever possible.
3. Install the trap close to the drip point.

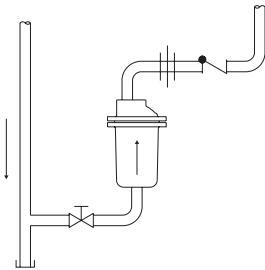
Trap Hookups. For low and medium pressure service, see Figs. 3-1 through 6-1. Follow the Power Piping Code for Drips and Drains when installing high pressure traps.



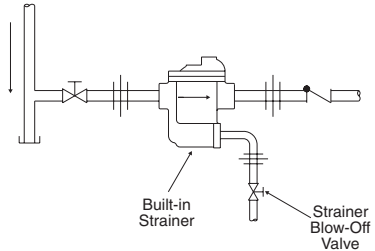
**Fig. 3-1.** Standard hookup No. 800-816, 800-883 traps, with shut-off valves to isolate trap during testing, inspection or repair. Unions should be at right angles—not in-line—to facilitate trap removal.



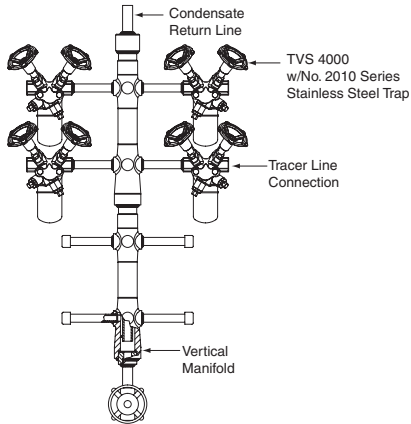
**Fig. 3-3.** Alternate hookup for No. 800-816 with inlet at bottom.



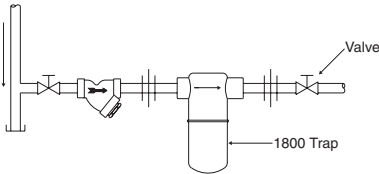
**Fig. 3-2.** Hookup No. 211-216 traps.



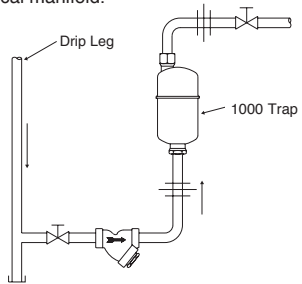
**Fig. 3-4.** No. 880-883 with strainer blow-down valve.



**Fig. 4-1.** Hookup for vertical manifold.



**Fig. 4-2.** Hookup for No. 1800 Series Stainless Steel trap.

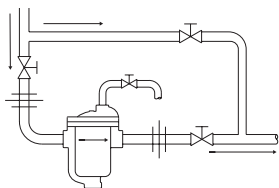


**Fig. 4-3.** Hookup for No. 1000 Series Stainless Steel trap.

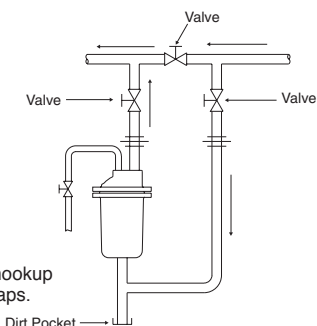
**Shut-Off Valves** ahead of traps are needed when traps drain steam mains, large water heaters, etc., where system cannot be shut down for trap maintenance. They are not needed for small steam heated machines – laundry presses, for example. Shut-off valve in steam supply to machine is sufficient.

Shut-off valve in trap discharge line is needed when trap has a bypass. It is also a good idea when there is high pressure in the discharge header.

**Bypasses** (Figs. 5-1 and 5-2). Bypasses are discouraged, for if left open, they will defeat the function of the trap. They are shown here for reference only. If continuous service is absolutely required, use two traps in parallel, one as a primary, one as a standby.



**Fig. 5-1.** Bypass hookups for No. 800-816 and 880-883 traps.



**Fig. 5-2.** Bypass hookup for No. 211-216 traps.

**Unions.** If only one is used, it should be on discharge side of trap. With two unions, avoid horizontal or vertical in-line installations. The best practice is to install at right angles as in Figs. 3-1 and 5-1 or parallel as in Fig. 5-2.

**Standard Connections.** Servicing is simplified by keeping lengths of inlet and outlet nipples identical for traps of a given size and type. A spare trap with identical fittings and half unions can be kept in the storeroom. In the event a trap needs repair it is a simple matter to break the two unions, remove the trap, put in the spare and tighten the unions. Repairs can then be made in the shop and the repaired trap, with fittings and half unions, placed back in stock.

**Test Valves** (Fig. 3-1) provide the best means of checking trap operation. Provide a shut-off valve or a 3-way valve in the discharge line to isolate trap while testing. For best results, use a valve the same line size as the test port and use a fully ported valve.

**Strainers.** Install strainers ahead of small traps when dirt conditions are bad or where specified. They are seldom needed with larger size traps.

Traps No. 880-883 have built-in strainers. When strainer blow-down valve is used, shut off steam supply valve before opening strainer blow-down valve. Condensate in trap body will flash back through strainer screen for thorough cleaning. Open steam valve slowly to be sure trap regains its prime.

**Dirt Pockets** (Figs. 3-1 and 5-2) are excellent for stopping scale and core sand. Clean periodically.

**Syphon Installations** require a water seal and a check valve in the trap. Syphon pipe should be one size smaller than nominal size of trap used but not less than 1/2" pipe size.

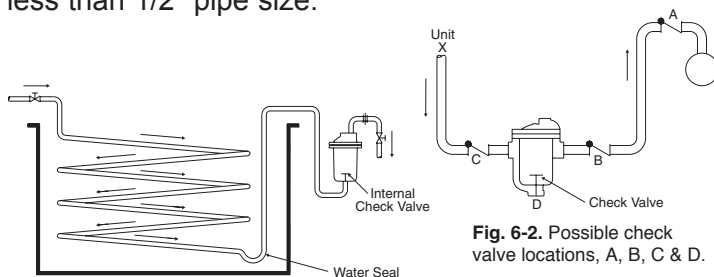


Fig. 6-1. Trap draining syphon.

Fig. 6-2. Possible check valve locations, A, B, C & D.

**Elevating Condensate.** Do not over-size the vertical riser. In fact, one pipe size smaller than normal for the job will give excellent results. Pipe size should not be less than 1/2".

**Check Valves** prevent backflow of condensate into a heat exchanger when the control valve closes or the steam supply is manually shut off.

Discharge Line Check Valves are normally installed at location B, Fig. 6-2. When the return is elevated and the trap is exposed to freezing conditions, install the check valve at location A, Fig. 6-2.

Inlet Line Check Valves prevent loss of water seal (trap prime) if pressure should drop suddenly or if trap is above drip point. An Armstrong Stainless Steel Check Valve in the trap's body is recommended. (See location D, Fig. 6-2. Also see pages 19 and 20.) If swing check valve is used, install at location C, Fig. 6-2.

## Anti-Freeze Precautions

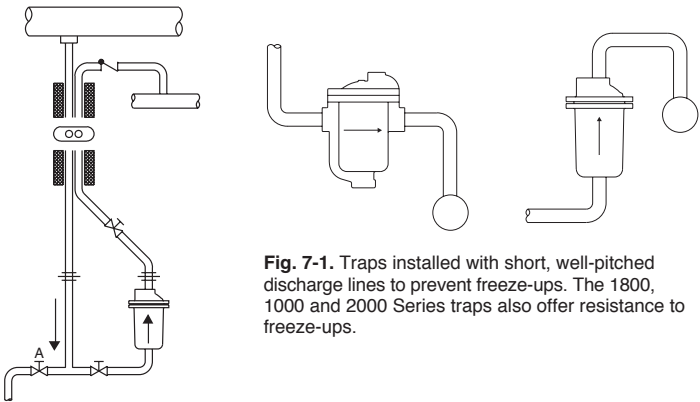
1. Do not over-size steam trap.
2. Keep discharge line very short.
3. Pitch discharge line down for fast gravity drainage.

4. For maximum freeze protection utilize all stainless steel 1800, 1000 or 2000 Series traps in a vertical or horizontal manifolded condensate return system.

NOTE: A long horizontal discharge line invites trouble. Ice can form at the far end eventually sealing off the pipe. This prevents the trap from operating. No more steam can enter the trap, and the water in the trap body freezes potentially damaging the trap.

## Discharge to a return line.

1. Keep discharge line short with a sharp pitch to header.
2. If return line is overhead, run vertical discharge line adjacent to drain line to top of return header and insulate drain line and trap discharge line together. See Fig. 7-2.



**Fig. 7-1.** Traps installed with short, well-pitched discharge lines to prevent freeze-ups. The 1800, 1000 and 2000 Series traps also offer resistance to freeze-ups.

**Fig. 7-2.** Outdoor installation to permit ground level trap testing and maintenance when steam supply and return lines are high overhead. Drain line and trap discharge line are insulated together to prevent freezing. Note location of check valve in discharge line and blow-down valve A that drains the steam main when trap is opened for cleaning or repair.

**Protection Against Freezing.** In general, a properly selected and installed Armstrong Trap will not freeze as long as steam is coming to the trap. If the steam supply should be shut off, the trap should be drained manually or automatically by means

of a Pop Drain. Note: Pop Drains discharge hot condensate. Be sure this discharge does not present a personnel hazard.

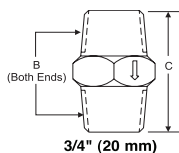
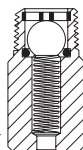
**Pop Drains** close when increasing line pressure seats ball valve against the resistance of a stainless steel spring. They open when decreasing line pressure allows the spring to push the ball valve off its seat.

Fig. No.	Connection	Pressure Range	Max. Operating Temperature	Seat Type	Opens	Closes
8-1	1/2"	15-600 psi	350°F	"O" Ring	4 psi	6 psi
8-1	3/4"	15-600 psi	350°F	"O" Ring	4 psi	6 psi

**Note:** Pop Drains may not be used with inlet tube or check valve. Do not use Pop Drains in locations where normal operating pressure could drop below 15 psig.

**Fig. 8-1.**  
One Piece  
Stainless Steel  
Pop Drain

One Piece  
Stainless Steel  
Pop Drain





# Testing Armstrong Traps

For maximum trap life and steam economy, a regular schedule should be set up for trap testing and preventive maintenance. Trap size, operating pressure and importance determine how frequently traps should be checked.

Suggested Yearly Trap Testing Frequency				
Operating Pressure (psig)	Application			
	Drip	Tracer	Coil	Process
0-100	1	1	2	3
101-250	2	2	2	3
251-450	2	2	3	4
451 and above	3	3	4	12

## How To Test

**Test Valve Method is best.** Fig. 3-1 shows correct hookup, with shut-off valve in return line to isolate trap from return header.

Here is what to look for when test valve is open.

- a. **Intermittent discharge**—trap is okay.
- b. **“Flash” steam**—do not mistake this for a steam leak through the trap valve. Condensate under pressure holds more heat units—btu’s—per pound than condensate at atmospheric pressure. When condensate is discharged, these extra heat units re-evaporate some of the condensate. See page 30.
- c. **Dribble or semi-continuous discharge**—trap is okay. This type of discharge is caused by air mixed with steam or a light condensate load.
- d. **Continuous steam blow**—trouble. Refer to page 16.
- e. **Continuous condensate flow**—trouble. Refer to page 17.
- f. **No Flow**—possible trouble. Refer to page 15 **Cold Trap**—or page 16 **Hot Trap**.

**Pyrometer Method of Testing.** This method of testing is still used today, however current research has shown that information from this method is not as valid as the ultrasonic stethoscope.

**Listening Method of Testing.** The ultrasonic stethoscope is the most accurate and up-to-date device available for testing traps today. An ultrasonic stethoscope can be used to listen to the outlet of the trap and “hear” the flow. It should be remembered that an ultrasonic stethoscope helps detect the need for quick preventive maintenance.

**Inverted Bucket Air Trap Operation.** There is an intermittent air loss through an inverted bucket trap draining water from compressed air. This is the air that passes through the small vent in the top of the bucket and amounts to approximately 10 cu. ft. of free air per hour. When the trap has a lot of water to handle, the air loss is materially reduced. **All inverted bucket air traps *must* be primed before starting service on an air system.**

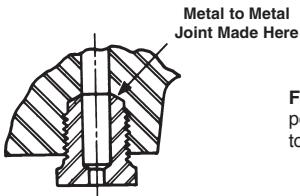
## Inspection and Repair

**Frequency:** All repairable traps should be opened at least once a year to check the operating mechanism.

**Valves and Seats.** If the valve seat has a sharp smooth edge, and if there is a narrow bright ring all the way around the ball valve, chances are that the valve is tight. Valves and seats which have become wire drawn or badly grooved from wear should be replaced. **Do not use a new seat with an old valve or vice versa.** Valves and seats are factory-lapped together in matched sets for perfect fit.

**Years of experience have proved that when valves and seats have worn enough to require renewal, a new lever and guide pin assembly should also be installed to get maximum performance from the new valve parts.**

**Valve Seat Installation.** When installing valve seats in Armstrong traps, **do NOT use any pipe dope or lubricant of any kind on the seat threads.** The joint is made, not by the threads, but rather by the contact between the ground end of the valve seat and the beveled seating area at the bottom of the tapped hole. See Fig. 10-1. Make sure that this seating area is perfectly clean.

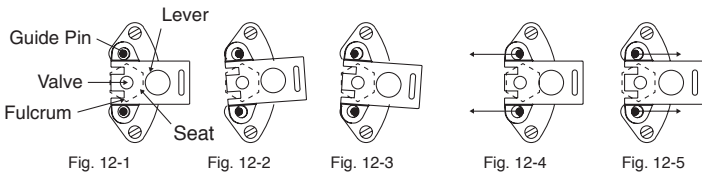


**Fig. 10-1. Important!** Valve seat seal is made at point of contact indicated, not by threads. Be sure to read paragraph above.

**Replace Lever and Guide Pin Assembly.** When new valve parts are used with an old lever, bucket travel, valve opening and trap capacity are reduced. With used and worn guide pins, the valve is not guided as closely to its seat. Poor guidance develops leaks quickly because the valve can strike the side of the seat instead of the center.

When you install a new mechanism less bucket or a pressure change assembly, you make the trap as good as new.

**Alignment of Guide Pins.** To check the alignment of the guide pins, hold the lever assembly against the valve seat with the valve contacting its seat, and the two fulcrum points resting on the face of the seat. When the lever is held in this position, the guide pins should be central in the guide pin holes. See Fig. 12-1. There should be equal side-to-side movement of lever as shown in Fig. 12-2 and Fig. 12-3. It is a very simple matter to bend the pins until they are centrally located. Care should be taken so that the pins will remain perpendicular to the guide pin plate so that the lever can drop until it rests on the guide pin hooks.



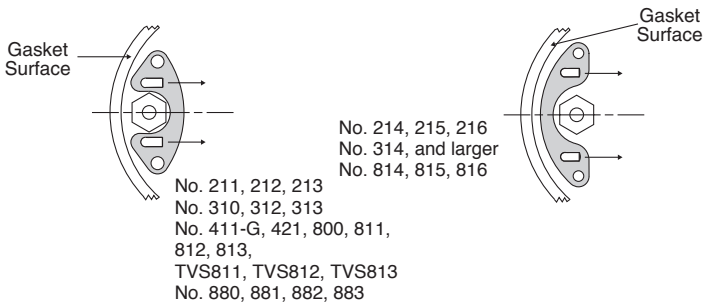
**Fig. 12-1** shows CORRECT ALIGNMENT of guide pins. When correctly aligned, lever can be moved sideways the same distance to the right (**Fig. 12-2**) as to the left (**Fig. 12-3**).

**Figs. 12-4 & 12-5** show two examples of INCORRECT ALIGNMENT. Guide pins should be bent in direction of arrows until they center in holes as shown in Fig. 12-1.

**Guide Pin Assembly Installation.** Install with guide pins pointing away from the adjoining gasket surfaces as shown in Fig. 12-6.

**The Lever Assembly** is hooked over the guide pins. In a few sizes of traps, particularly at low pressures, the valve lever assembly must be slipped on the guide pins before the guide pin assembly is fastened into position.

**Buckets.** Cracked or corroded buckets should be replaced.



**Fig. 12-6.** Guide Pin Plate Locations. Pins always point away from adjoining Gasket Surfaces.

**Thermic Buckets.** Hold over a steam jet or lighted match to see that disc seats properly when bi-metal strip is heated.

**Dirt in Trap.** Remove all sediment and other dirt from the trap body. The mechanism may require cleaning by immersing in approved cleaning fluid. Series 1000, 1800 and 2000 Stainless Steel traps may be

backflushed with compressed air or water under pressure to clean them. If there is an exceptional amount of dirt, install a strainer ahead of the trap. The strainer will have to be blown down or cleaned every 3-6 months, or as conditions warrant.

**By-Pass Valve Inspection.** If traps are installed with a by-pass, it is highly important that the by-pass valve be checked to make sure it is perfectly steam tight. If the trap can be operated without the by-pass, by all means remove it. Avoid the practice of opening by-pass valves and leaving them open.

**Internal Check Valve Installation.** Since November, 1946, all Armstrong trap bodies have been tapped on the inside to take Armstrong spring-loaded check valves. To install one of these check valves after a trap has been installed in the line, simply remove the trap cap and the extended inlet tube from the body and screw the check valve in position, or replace the inlet tube with a check valve, tube and coupling. This does **not** apply to Series 1800, 1000 or 2000 Stainless Steel traps.

**Check Valve Inspection.** Make sure that check valves ahead of traps, in traps, or in return lines, are tight and in good condition.

**Pressure Changes.** An Armstrong Steam Trap will operate at any pressure lower than the maximum for which it is furnished. The maximum pressure depends upon the diameter of the discharge orifice used in each size of trap. If it is necessary to change the working pressure of the trap to obtain greater capacity at lower pressures, or to enable the trap to work at higher pressures, a complete pressure change assembly (PCA) is required. This applies to all Armstrong inverted bucket traps **except** the Series 1800, 2000 and 1000 Stainless Steel traps where the complete trap needs to be replaced. The pressure change assembly (PCA) consists of a valve seat, a valve retainer, a valve lever

with valve, guide pin assembly and (2) two screws. The diameter of the valve seat is stamped on the face of the seat itself, on the valve lever, and on the guide pin assembly. Parts having different stampings should never be used together.

A valve lever and guide pin assembly are matched with the valve and seat to obtain the maximum possible leverage and trap capacity. At low pressure a low leverage is necessary to obtain full opening of the large orifice. As the orifice size decreases, less valve travel is required, hence, higher leverages can be employed. Because of this highly efficient leverage system, it is usually possible to handle a given job with an Armstrong Trap having pipe connections one size smaller than those of other makers.

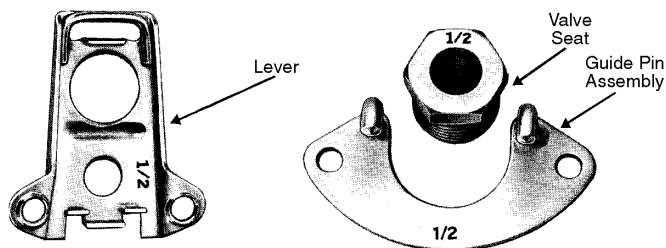


Fig. 14-1. Diameter of orifice is stamped on valve parts.

**How to Order Repair Parts.** For all operating mechanism parts, specify trap number and maximum operating pressure or orifice size. For gaskets, specify trap model number. For body and cap, specify trap model number and size of pipe connections.

## Trouble Shooting

The following summary will prove helpful in locating and correcting nearly all steam trap troubles. Many of these troubles are in reality system troubles rather than trap troubles.

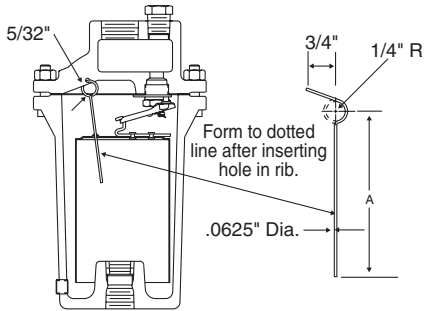
Whenever a trap fails to operate and the reason is not readily apparent, the discharge from the trap should be observed. If the trap is installed with a test outlet, this will be a simple matter—otherwise, it will be necessary to break the discharge connection.

**Cold Trap – No Discharge.** If trap fails to discharge condensate, then:

- A. Pressure may be too high.
  - 1. Wrong pressure originally specified.
  - 2. Pressure raised without installing new pressure change assembly (PCA).
  - 3. P.R.V. out of order.
  - 4. Pressure gage in boiler reads low.
  - 5. Orifice enlarged by normal wear.
- B. No water or steam coming to trap.
  - 1. Stopped by plugged strainer ahead of trap – or plugged screen in integral strainer traps.
  - 2. Broken valve in line to trap.
  - 3. Pipe line or elbows plugged.
- C. Worn or defective mechanism. Repair or replace as required.
- D. High Vacuum in return line. Increases pressure differential beyond which trap may operate. Install correct pressure change assembly for pressure *differential* encountered.
- E. Trap body filled with dirt. Install strainer or remove dirt at source.
- F. Bucket vent filled with dirt.  
Prevent by:
  - 1. Installing strainer.
  - 2. Enlarging vent slightly.
  - 3. Using bucket vent scrubbing wire.

Vent Scrubber. If the bucket vent could be closed by an oil film, either enlarge the vent or install a scrubbing wire. For vent enlargement, first try a No. 46 drill. If this is not enough, then use a No. 42 drill. Make scrubbing wire as shown in Fig. 16-1 to the length shown in Table 16-1. The hole in the center rib of the trap should be  $\frac{5}{32}$ ". Enlarge vent with No. 37 drill.

**Fig. 16-1.** Vent scrubbing wire for use when oil plugs vent. Trap inlet tube must be removed.



**Table 16-1**  
**Scrubbing Wire Dimension**

Trap Model Number	Length "A"
800, 880	1½"
211, 310, 411-G, 421, 811, 881, 981	2¼"
212, 312, 812, 882	3"
213, 214, 215, 313, 314, 315, 413, 813, 814, 815, 883, 983	5"
216, 316, 816	6½"

## Hot Trap – No Discharge.

- A. No water coming to trap.
1. Trap installed above leaky by-pass valve.
  2. Broken or damaged syphon pipe in syphon drained cylinder.
  3. Vacuum in heat exchanger coils may prevent drainage. Install a vacuum breaker between the heat exchanger and the trap.

**Steam Loss.** If the trap blows live steam, trouble may be due to any of the following causes:

Note: Be sure this is not flash steam.

- A. Valve may fail to seat.
1. Piece of scale lodged in orifice.
  2. Worn valve parts.
- B. Trap may lose its prime.
1. If the trap is blowing live steam, close the inlet valve for a few minutes to allow condensate to back up before the trap. Then gradually open simulating start up conditions. If the trap catches its prime, the chances are that the trap is all right.
  2. Prime loss is usually due to sudden or frequent



drops in steam pressure. On such jobs, the installation of a check valve is called for – location D or C in Fig. 6-2. If possible locate trap well below drip point.

**Continuous Flow.** If the trap discharges continuously, check the following:

- A. Trap too small.
  - 1. A larger trap, or additional traps in parallel should be installed.
  - 2. High pressure traps have been used for a low pressure job. Install correct size pressure change assembly (PCA).
- B. Abnormal water conditions.
  - 1. Boiler may foam or prime, throwing large quantities of water into steam lines. A separator should be installed or have the feed water conditions remedied.

**Sluggish Heating.** When trap operates satisfactorily but units fail to heat properly:

- A. One or more units may be short-circuiting and the remedy is to install a trap on each unit.
- B. Traps may be too small for job even though they may discharge intermittently. Try next-size-larger trap.
- C. Trap may have insufficient air-handling capacity, or air may not be reaching trap. In either case, use auxiliary air vents. Use of thermic buckets may help. See page 18.

**Mysterious Trouble.** If trap operates satisfactorily when discharging to atmosphere, but trouble is encountered when connected with the return line, check the following:

- A. Back Pressure may reduce capacity of trap.
  - 1. Return line too small (trap hot).
  - 2. Other traps may be blowing steam (trap hot).
  - 3. Atmospheric vent in condensate receiver may be plugged (trap hot or cold).

4. Obstruction in return line (trap hot or cold).
5. Excess vacuum in return line (trap cold).

**Imaginary Troubles.** If it appears that steam escapes every time trap discharges, remember: Hot condensate forms flash steam when released to lower pressure, but flash steam usually condenses quickly in the return line.

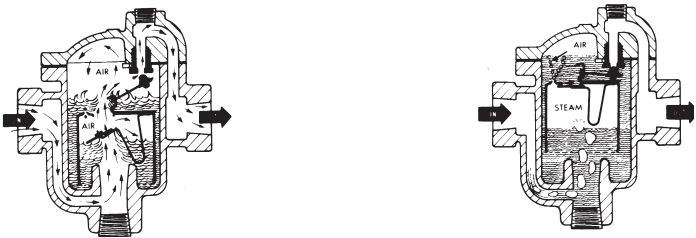
## Optional Accessories

### Thermic Vent Buckets

Wherever steam is turned on and off, air will accumulate in piping and steam equipment during the off period. A trap with a thermic bucket will discharge this air 50 to 100 times faster than a standard bucket, reducing heat-up time remarkably. Thermic vent buckets are available for Armstrong traps for use at pressures up to 250 psig.

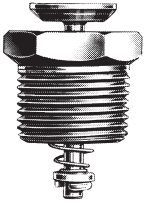
**Where to Use:** Single pipe coils; small on-and-off unit heaters; on-and-off multiple coils; drip points (particularly at ends of steam distribution mains); wherever air will pocket and be discharged ahead of incoming steam.

**Installation.** Before replacing a standard bucket with a thermic vent bucket, **be sure to remove the inlet tube from the trap body.** If this is not done, the thermic element will become distorted and trap will not work.



**Fig. 18-1**— Thermic bucket operation. At left, thermic vent is open and air “passes” through. At right, thermic vent is closed and trap operates same as a standard trap.

## Internal Check Valves

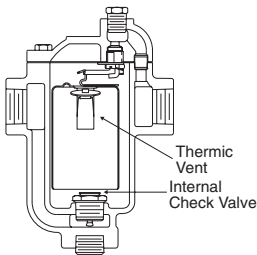


**Fig. 18-2.**  
Armstrong stainless steel internal check valve.

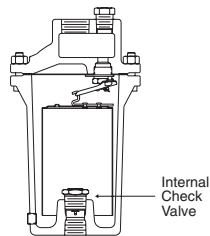
When either of the following conditions exists, check valves are needed between the trap and the unit drained:

1. Trap is installed above unit being drained.
2. Where sudden pressure drops may occur in the steam supply to the unit being drained.

Armstrong spring loaded, stainless steel internal check valves save fittings, labor and money when check valves are required. Cast iron traps may use the check valve screwed directly into the trap inlet (Fig. 19-2) or into an extended inlet tube having a pipe coupling at the top (Table 28-2). Trap No. 800T and 880T cannot use internal check valves in either manner. All other traps with numbers carrying a “T” suffix can use only check valves screwed directly into the trap inlet. Sizes are the same as those indicated in Table 20-1 for traps without “T” suffixes. Steel traps should employ the check valve, tube and coupling combination.



**Fig. 19-2.** Internal check valve installed in trap inlet.



**Fig. 19-3.** Internal check valve installed in trap inlet of 200 Series trap.

**Table 20-1 Check Valve Sizes To Use With Armstrong Traps**

Trap Model Number	Trap Connection Size						
	1/2"	3/4"	1"	1-1/4"	1-1/2"	2"	2-1/2"
800, 880, 881, 812, 882, 212, 310, 981	1/2"	1/2"					
211	1/2"						
811, TVS811	1/2"	1/2"	1/2"				
TVS812	3/4"	3/4"					
312, 411-G	3/4"	3/4"					
213	1/2"	3/4"	3/4"				
813, TVS813		3/4"	3/4"				
883		3/4"	3/4"	3/4"			
313, 413	3/4"	3/4"	3/4"				
5133-G	3/4"	3/4"	1"				
983	1"	1"	1"				
814, 214			1"	1"			
314, 6155-G			1"	1-1/4"			
215, 315, 415			1"	1-1/4"	1-1/4"		
815					1-1/2"		
5155-G		1"	1"	1-1/4"			
816						2"	2"
216, 316, 416					1-1/2"	2"	

## Trap Repairs and Change of Operating Pressure

Experience has proven that when valves and seats have worn enough to require renewal, a new lever and guide pin assembly should also be installed to get maximum performance from the new valve parts. When new valve parts are used with an old lever, bucket travel, valve opening and trap capacity are reduced. With used and worn guide pins, the valve is not guided as closely to its seat. Poor guidance develops leaks quickly because the valve can strike the side of the seat instead of in the center. Accordingly, replacement parts are supplied only in matched sets comprising the pressure change assembly (PCA).

**A Mechanism Less Bucket or Pressure Change Assembly (PCA)** includes: valve seat, valve retainer, lever with valve and guide pin assembly with screws. These parts come in matched sets with orifice size stamping on the lever and guide pin assembly, as well as on the orifice (seat) itself—see Pressure Change Assembly (PCA).

**A Mechanism Less Bucket** — Pressure Change Assembly (PCA) (no change in operating pressure) will make an old trap practically as good as new since the trap bucket is not normally subjected to great wear. When ordering, specify maximum working pressure.

<b>Table 21-1 Interchangeability of Parts</b>		
<b>Part Name</b>	<b>Trap Size</b>	<b>Interchangeable in:</b>
Cap	800	880, 811, 881, TVS811
	812	882, TVS812
	813	883, TVS813
Gasket	800	800, 811, 881, TVS811
	812	882, TVS812
	813	883, 983, TVS813
	316	415
Bolts and Nuts	800	880, 811, 881
	211	212
	812	882
	813	883
	814	
Thimble	800	880, 811, 881, TVS811
	812	882, TVS812
	813	983, 883, TVS813
Bucket	800	880
	211	811, 881, 310, TVS812
	212	812, 882, TVS812
	213	813, 313, 413, 983, 883, TVS813
	214	814, 314
	215	815
	216	316, 416 (up to 700 lbs), 816
Strainer Screen	880	881, 981, TVS811
	882	TVS812
	883	TVS813

*Buckets for traps with "T" or "LV" suffix are interchangeable only for identical pressures.*

**A Pressure Change Assembly (PCA)** (or Mechanism Less Bucket) with a smaller orifice will enable the trap to operate at a higher pressure, or, with larger orifice will give greater capacity at a pressure lower than that for which it originally was ordered. This comprises a valve seat, a valve, valve retainer, valve lever and guide pin assembly and screws. The diameter of the valve seat is stamped on the face of the seat itself, on the valve lever, and on the guide pin assembly. **Parts having different stampings should never be used together.**

A valve lever and guide pin assembly are matched with the valve and seat to obtain the maximum possible leverage and trap capacity. At low pressure a low leverage is necessary to obtain full opening of the large orifice. As the orifice size decreases, less valve travel is required, hence, higher leverages can be employed.

**Table 22-1 Maximum Working Pressures for Pressure Change Assemblies (PCA)**

Size Orifice	Trap Model Numbers												
	800 880	211 811 881 TVS811 310	981	421 411-G	212 TVS812 812 882	312	213 813 TVS813 313 413 883 983	214 814 815	215 315 415 816	216 316 416	5133-G	5155-G	6155-G
5/64		*400	600	1000									
#38	150	250	325	600									
7/64	125	200	250		250	*600	*1100				*1500		*2700
1/8	80	125	175		200	*450	*950				*1200	*1800	*2500
5/32		70	85		125	225	*450	*650	*1000		*800	*1350	*2000
3/16	20	30	50		70	150	250	*550	*800				*1400
7/32						90	180	*375	*500	*1000			
1/4		15	20		30	60	125	250	*350	*700			
9/32						40	80	180	225	*600			
5/16					15	25	60	125	180	*500			
11/32								80	130	*370			
3/8						15	30	60	100	250			
7/16									60	180			
1/2						10	15	30		125			
9/16									30	80			
5/8								15		60			
3/4									15	40			
7/8										25			
1-1/16										15			

\*Steel Traps Only

Parts in shaded areas are interchangeable but for different pressures.

# Ordering Repair Parts

When ordering replacement parts for repairable Armstrong inverted bucket traps, please specify the following information:

**For bodies and caps:** Trap Model No. and pipe connection size.

**For mechanisms and buckets:** Trap Model No. and maximum working pressure or orifice size.

**For all other parts:** Trap Model No.

## Visual Identification of Mechanism Parts

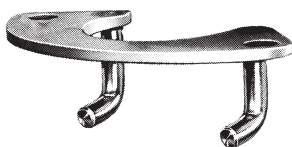


Fig. 23-1. Guide Pin Assembly



Fig. 23-2. Valve Seat

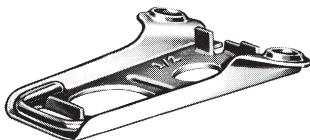


Fig. 23-3. Valve Lever



Fig. 23-4. Valve



Fig. 23-5. Valve Retainer

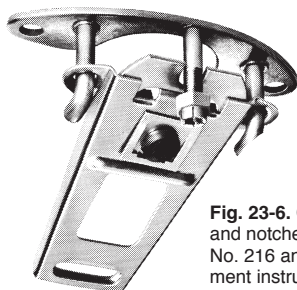
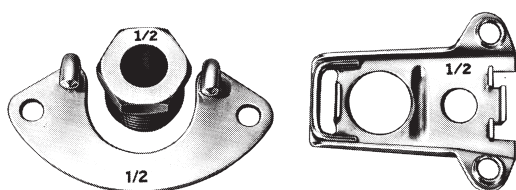


Fig. 23-6. Guide pin assembly with post and notched lever employed in 15 psi No. 216 and 816 traps only. See adjustment instructions packed with assembly.

# Identification of Trap Parts by Dimensions

The following dimensional data will enable you to identify any Armstrong free-floating lever trap part should there be any doubt as to the trap size to which it belongs.

**In the case of valves, seats, levers and guide pin assemblies, parts must be mated by orifice size.** Orifice sizes are stamped on valve levers, valve seats and guide pin assemblies as shown below.



**Fig. 24-1**  
Orifice  
Stamping

Valves and valve seats are factory-lapped together in matched sets to provide a perfect fit and should be retained in sets. **Do not attempt to pair miscellaneous valves and seats.** This could cause a steam leak. The orifice size dimensions in Table 24-1 will enable you to determine the orifice size to which a valve belongs.

**Table 24-1 Dimensional Identification Data,  
Orifices and Valves**

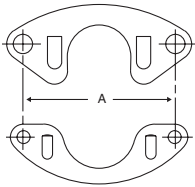
Dimension D-2 Valve, page 25	For Orifice Size	Dimension D-2 Valve, page 25	For Orifice Size
1/8"	#38 drill size	13/32"	11/32"
1/8"	7/64", 5/64"	1/2"	3/8"
5/32"	1/8"	9/16"	7/16"
3/16"	5/32"	21/32"	1/2"
7/32"	3/16"	23/32"	9/16"
9/32"	7/32"	13/16" (.7962")	5/8"
5/16" *	1/4"	1" (.9528")	3/4"
11/32"	9/32"	1-1/8" (1.071")	7/8"
3/8"	5/16"	1-3/8" (1.272")	1-1/16"

\*No. 213, 813 and larger have 5/16" dimension D-2 for 1/4" orifice.  
For smaller traps, dimension D-2 is 9/32" for 1/4" orifice.

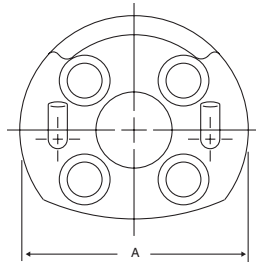


**Table 25-1 Dimensional Identification Data,  
Valves, Seats, Levers, Retainers, Guide Pin Assemblies**

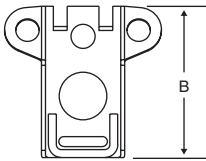
Trap Size	A	B	D	D-1	E	F
800, 880, 811, 881, TVS811 310, 211, 411-G, 421, 981	1-1/2"	13/16"	3/16"	1/8"	1/2"	3/16"
212, 812, 882, TVS812	1-7/8"	1-21/32"	3/16"	1/8"	5/8"	3/16"
213, 312, 313, 413, 813, 883, 983, TVS813	2-5/16"	2-7/64"	*	*	7/8"	1/4"
214, 814, 314	2-3/4"	2-15/32"	*	*	1"	1/4"
215, 315, 415, 815	3-1/8"	2-11/16"	*	*	1-1/4"	1/4"
216, 316, 416, 816	3-5/8"	3-1/2"	*	*	1-1/2"	5/16"
5133-G	2-1/4"	2-7/64"	1/4"	3/16"	57/64"	5/16"
5155-G	2-3/4"	2-11/16"	1/4"	3/16"	1-7/64"	5/16"
6155-G	2-3/4"	2-11/16"	1/4"	3/16"	1-7/64"	5/16"
	*(w/orifice 1/8" thru 3/8")		1/4"	3/16"		
	*(w/orifice 7/16" thru 9/16")		3/8"	5/16"		
	*(w/orifice 5/8" thru 11/16")		1/2"	3/8"		



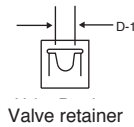
Guide pin assemblies,  
Cast Iron Traps and  
300, 400 series traps.



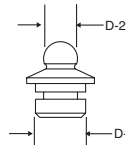
Valve seat retainer with guide  
pins, No. 5133-G, 5155-G,  
6155-G traps.



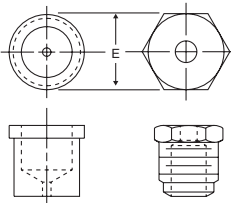
Valve lever



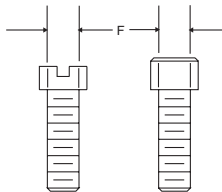
Valve retainer



Valve



Valve seat, No. 5133-G,  
5155-G, 6155-G (left); all  
others (right).



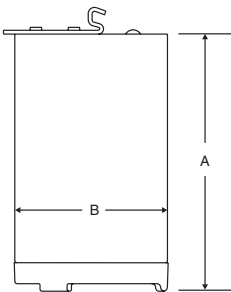
Screws for standard guide pin  
assemblies (left) and for 5133-G,  
5155-G, 6155-G traps only (right).

**Table 26-1 Dimensional Identification Data, Buckets**

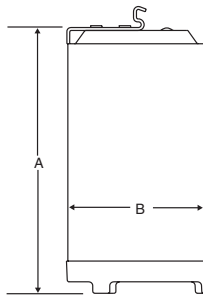
Trap Model No.	Weight of Bucket (ounces)	Length "A"	Diameter "B"	Clip Length "C"	Standard Bucket Vent Size
800, 880	1-27/32	1-13/16"	2"	1"	.094"
211, 310, 811, 881, TVS811	3-1/4	3"	2"	1"	.081"
981	4	3-3/4"	2"	1"	.081"
212, 812, 882, TVS812	7	3-15/16"	2-3/4"	1-5/16"	0 - 30 PSI - .081" 31 + PSI - .067"
411-G	7-1/2	3-15/16"	2-3/4"	1"	.067"
312	8-1/16	3-7/8"	3"	1-3/4"	0 - 40 PSI - .081" 41 + PSI - .067"
213, 313, 413, 813, 883, 983, TVS813	14	5-15/32"	3-1/2"	1-3/4"	0 - 60 PSI - .081" 61 + PSI - .067"
5133-G	*	7-3/8"	3-1/2"	1-3/4"	0 - 60 PSI - .081" 61 + PSI - .067"
214, 814, 314	24	6-5/8"	3-1/2"	2"	0 - 60 PSI - .081" 61 + PSI - .067"
215, 815	36	7-11/16"	4"	2-3/16"	0 - 60 PSI - .081" 61 + PSI - .067"
315, 415	36	8"	4-1/2"	2-3/16"	0 - 60 PSI - .081" 61 + PSI - .067"
5155-G	36	8-5/8"	4-1/2"	2-3/16"	0 - 60 PSI - .081" 61 + PSI - .067"
216, 316, 416, 816	66	8-1/2"	5"	2-13/16"	0 - 60 PSI - .081" 61 + PSI - .067"
416 (above 700 psi)	50	8-1/2"	5"	2-13/16"	0 - 60 PSI - .081" 61 + PSI - .067"
6155-G	*	14-5/8"	4-1/2"	2-3/16"	0 - 60 PSI - .081" 61 + PSI - .067"
421	7-45/64"	4-9/32"	2-11/16"	1"	0 - 60 PSI - .081" 61 + PSI - .067"

\*Bucket weight varies with orifice size and operating pressure.

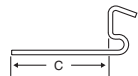
NOTE: Consult your Armstrong Representative for information on "T" or "LV" Bucket Vent sizes.



**Fig. 26-1.** Bucket Dimensions.



**Fig. 26-2.** No. 315, 415, 5155-G and 6155-G traps only.

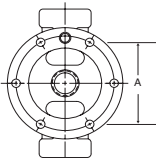


**Fig. 26-3.** Bucket Clip Dimensions.

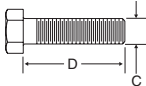
**Table 27-1 Dimensional Identification Data,  
Bodies, Caps and Gaskets**

Trap Model No.	Diam. Bolt Circle "A"	No. Bolts	Body Height "B"	Bolt Data		Pipe Plugs		Gaskets			Thimble	
				"C"	"D"	Body	Cap	I.D.	O.D.	Type	Diam.	Lgth.
800	3-3/16"	6	4-1/8"	1/4"	1"	1/2"	1/4"	2-3/8"	2-7/8"	2	3/8"	5/16"
811	3-3/16"	6	5-17/32"	1/4"	1"	*1/2"	1/4"	2-3/8"	2-7/8"	2	3/8"	5/16"
TVS811	3-3/16"	6	5-13/16"	M6	20mm	3/4"	1/4"	2-3/8"	2-7/8"	2	3/8"	5/16"
880	3-3/16"	6	4-3/4"	1/4"	1"	3/8"	1/4"	2-3/8"	2-7/8"	2	3/8"	5/16"
881	3-3/16"	6	4-3/4"	1/4"	1"	3/8"	1/4"	2-3/8"	2-7/8"	2	3/8"	5/16"
211	3-9/16"	6	4-3/4"	5/16"	1-1/4"	—	1/8"	2-1/2"	2-7/8"	1	—	—
310	3-3/4"	6	5-15/16"	3/8"	1-5/8"	—	—	2-1/2"	3"	1	—	—
981	3-3/4"	6	6-15/16"	3/8"	1-5/8"	—	1/2"	2-1/2"	3-1/4"	2	1/2"	5/16"
212	4-9/16"	6	5-7/8"	5/16"	1-1/4"	—	3/8"	3-3/8"	4"	1	—	—
411-G	5-1/4"	8	6-7/8"	1/2"	2-1/2"	—	—	3-3/4"	4-3/8"	1	—	—
812	4-3/4"	6	6-1/4"	3/8"	1-5/8"	*1/2"	1/2"	3-3/8"	3-7/8"	2	3/4"	3/8"
TVS812	4-3/4"	6	7-3/8"	M10	30mm	*1/2"	1/2"	3-3/8"	3-7/8"	2	3/4"	3/8"
882	4-3/4"	6	7-5/8"	3/8"	1-5/8"	3/8"	1/2"	3-3/8"	3-7/8"	2	3/4"	3/8"
213	5-1/2"	6	7-7/8"	3/8"	1-1/2"	—	1/2"	4-1/4"	5-1/8"	1	—	—
312	5-5/8"	6	7-29/32"	1/2"	2-1/4"	—	—	4"	4-3/4"	1	—	—
813	5-3/4"	6	9-15/32"	1/2"	2"	1/2"	3/4"	4-1/4"	4-7/8"	2	15/16"	7/16"
TVS813	5-3/4"	6	10"	M12	40mm	1/2"	3/4"	4-1/4"	4-7/8"	2	15/16"	7/16"
883	5-3/4"	6	9"	1/2"	2"	1/2"	3/4"	4-1/4"	4-7/8"	2	15/16"	7/16"
983	6"	6	10-3/16"	5/8"	2-3/8"	1/2"	3/4"	4-1/4"	4-7/8"	2	15/16"	7/16"
214	6-1/2"	8	9-9/16"	3/8"	1-3/4"	—	3/4"	5"	5-3/4"	1	—	—
313	6-5/8"	8	9-3/8"	5/8"	2-3/4"	—	—	4-1/4"	5 5/8"	1	—	—
5133-G	6-5/8"	8	12-1/4"	7/8"	4-1/4"	—	—	4-21/32"	5-15/32"	1	—	—
814	6-7/8"	8	11-1/16"	1/2"	2"	1"	1"	4-7/8"	5-5/8"	2	15/16"	7/16"
413	7-1/8"	8	9-3/8"	3/4"	3-3/8"	—	—	5-1/8"	5-1/8"	1	—	—
314	7-1/8"	8	11-1/16"	3/4"	3-3/8"	—	—	5"	5-3/4"	1	—	—
815	7-1/2"	8	12-13/16"	1/2"	2-1/2"	1-1/2"	1-1/2"	5-5/8"	6-3/8"	3	—	—
215	7-1/2"	8	10-9/16"	1/2"	2"	—	3/4"	5-5/8"	6-11/16"	1	—	—
315	8"	9	12-7/16"	3/4"	3-1/2"	—	—	5-5/8"	6-11/16"	1	—	—
5155-G	8-1/4"	10	14-1/8"	1"	5"	—	—	5-3/4"	6-23/32"	1	—	—
415	8-3/4"	9	12-9/16"	1"	3-3/4"	—	—	5-5/8"	6-11/16"	1	—	—
216	9"	12	12-1/2"	1/2"	2-1/4"	—	1"	7"	8-3/8"	1	—	—
6155-G	9-3/8"	10	20-3/8"	1-1/4"	6-3/4"	—	—	5-3/4"	6-23/32"	1	—	—
316	10"	10	14-3/4"	7/8"	3-1/2"	—	—	7-5/8"	8-3/8"	1	—	—
416	10-1/2"	12	14-11/16"	1"	4-3/4"	—	—	7-5/8"	8-3/8"	1	—	—
816	9-1/2"	8	16-11/16"	5/8"	3"	2"	2"	7-1/2"	8-1/2"	3	—	—
421	5-1/4"	8	6-7/8"	1/2"	2-1/2"	—	3/4"	3-3/4"	4-3/8"	1	—	—

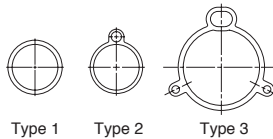
\*May be 3/4"



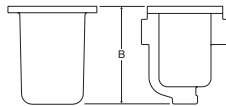
**Fig. 27-1. Bolt Circle**



**Fig. 27-3. Bolt dimensions**



**Fig. 27-2. Gasket Types**



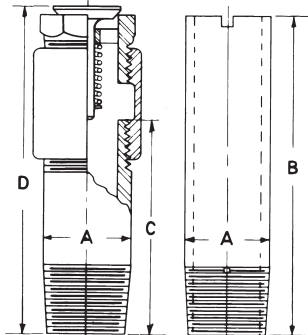
**Fig. 27-4. Body height**

**Table 28-1 Dimensional Data, Inlet Tubes**

Trap Model No.	Inlet Tube Pipe Size "A"	Tube Length (Std.) "B"	Tube Length with Check Valve	
			"C"	"D"
800, 880	1/2"	1-3/8"	—	—
211	1/2"	1-3/8"	1-1/8"	2-9/16"
310, 811, 881, 212, TVS811	1/2"	1-3/8"	1-1/8"	2-9/16"
812, 882, 981, 312 (1/2"), 213 (1/2"), 411-G (1/2")	1/2"	2-3/8"	2-1/2"	3-15/16"
312 (3/4"), 411-G (3/4"), 213 (3/4", 1"), TVS812	3/4"	2-1/2"	2"	3-3/4"
983	1"	3-3/4"	2"	3-7/8"
313, 413, 813, 883, TVS813	3/4"	3-1/2"	3"	4-3/4"
5133-G (3/4")	3/4"	6-7/8"	4-1/2"	6-1/4"
214	1"	3-3/4"	3"	4-7/8"
215 (1")	1"	5"	3"	4-7/8"
814, 314 (1"), 215 (1")	1"	5"	4-1/2"	6-3/8"
5133-G (1")	1"	6-7/8"	4-1/2"	6-3/8"
315 (1"), 415 (1"), 5155-G (3/4", 1")	1"	7-7/8"	5-1/2"	7-3/8"
6155-G (1")	1"	14"	12"	13-7/8"
215 (1-1/4")	1-1/4"	4-1/2"	3-1/2"	5-9/16"
314 (1-1/4")	1-1/4"	4-1/2"	4"	6-1/16"
315 (1-1/4"), 415 (1-1/4"), 5155-G (1-1/4")	1-1/4"	7-7/8"	5"	7-1/16"
815	1-1/2"	6-3/4"	3-1/2"	5-9/16"
6155-G (1-1/4")	1-1/4"	14"	12"	14-1/16"
216 (1-1/2")	1-1/2"	6-3/4"	3-1/2"	5-9/16"
316 (1-1/2"), 416 (1-1/2")	1-1/2"	8-1/2"	5-1/2"	7-9/16"
216, 816 (2")	2"	6-3/4"	3-1/2"	5-5/8"
316 (2"), 416 (2")	2"	8-1/2"	5-1/2"	7-5/8"

**Table 28-2 Dimensional Data, Inlet Tubes for Use with Thermic Buckets**

Trap Model No.	Pipe Size	
	Diameter "A"	Diameter "B"
811T, 881T, 212T, 310T, TVS811	1/2"	1 3/8"
812T, 882T, 213T (1/2")	1/2"	2 3/8"
213T (3/4"), TVS812	3/4"	2 1/2"
813T, 883T, TVS813	3/4"	3 1/2"
214T, 983T	1"	3 3/4"
215T	1 1/4"	4 1/2"
814T	1"	5"
815T, 216T	1 1/2"	4"
816T	2"	6 3/4"



Tube with check valve and coupling.

Standard tube or for use with thermic bucket.

# Definitions

**Saturated Steam** is pure steam at the temperature that corresponds to the boiling temperature of water at the existing pressure.

**Absolute and Gage Pressures.** Absolute pressure (psia) is pressure in pounds per square inch above a perfect vacuum. Gage pressure is pressure in pounds per square inch above atmospheric pressure which is 14.7 pounds per square inch absolute. Gage pressure (psig) plus 14.7 equals absolute pressure. Or, absolute pressure minus 14.7 equals gage pressure.

**Pressure-Temperature Relationship** (Columns 1, 2 and 3 on page 30.) For every pressure of pure steam there is a corresponding temperature. Example: Temperature of 250 psig pure steam always is 406°F.

**Heat of Saturated Liquid** (Column 4 on page 30.) This is the amount of heat required to raise the temperature of a pound of water from 32°F. to the boiling point at the pressure shown. It is expressed in btu's.

**Latent Heat of Heat Evaporation.** (Column 5 on page 30.) This is the amount of heat (expressed in btu's) required to change a pound of boiling water to a pound of steam. This same amount of heat is released when a pound of steam is condensed back into a pound of water. This heat quantity is different for every pressure-temperature combination as shown in the steam table.

**Total Heat of Steam** (Column 6 on page 30) is the sum of the Heat of the Saturated Liquid (Column 4) and Latent Heat (Column 5) in btu's. It is the total heat in steam above 32°F.

# Steam Tables

**Table 30-1 Properties of Saturated Steam**

(Abstracted from Keenan and Keyes, THERMODYNAMIC PROPERTIES OF STEAM, by permission of John Wiley & Sons, Inc.)

	Col. 1 Gauge Pressure	Col. 2 Absolute Pressure (psia)	Col. 3 Steam Temp. (°F)	Col. 4 Heat of Sat. Liquid (btu/lb)	Col. 5 Latent Heat (btu/lb)	Col. 6 Total Heat of Steam (btu/lb)	Col. 7 Specific Volume of Sat. Liquid (cu ft/lb)	Col. 8 Specific Volume of Sat. Steam (cu ft/lb)
Inches of Vacuum	29.743	0.08854	32.00	0.00	1075.8	1075.8	0.016022	3306.00
	29.515	0.2	53.14	21.21	1063.8	1085.0	0.016027	1526.00
	27.886	1.0	101.74	69.70	1036.3	1106.0	0.016136	336.60
	19.742	5.0	162.24	130.13	1001.0	1131.0	0.016407	73.52
	9.562	10.0	193.21	161.17	982.1	1143.3	0.016590	38.42
	7.536	11.0	197.75	165.73	979.3	1145.0	0.016620	35.14
	5.490	12.0	201.96	169.96	976.6	1146.6	0.016647	32.40
	3.454	13.0	205.88	173.91	974.2	1148.1	0.016674	30.06
	1.418	14.0	209.56	177.61	971.9	1149.5	0.016699	28.04
psig	0.0	14.696	212.00	180.07	970.3	1150.4	0.016715	26.80
	1.3	16.0	216.32	184.42	967.6	1152.0	0.016746	24.75
	2.3	17.0	219.44	187.56	965.5	1153.1	0.016768	23.39
	5.3	20.0	227.96	196.16	960.1	1156.3	0.016830	20.09
	10.3	25.0	240.07	208.42	952.1	1160.6	0.016922	16.30
	15.3	30.0	250.33	218.82	945.3	1164.1	0.017004	13.75
	20.3	35.0	259.28	227.91	939.2	1167.1	0.017078	11.90
	25.3	40.0	267.25	236.03	933.7	1169.7	0.017146	10.50
	30.3	45.0	274.44	243.36	928.6	1172.0	0.017209	9.40
	40.3	55.0	287.07	256.30	919.6	1175.9	0.017325	7.79
	50.3	65.0	297.97	267.50	911.6	1179.1	0.017429	6.66
	60.3	75.0	307.60	277.43	904.5	1181.9	0.017524	5.82
	70.3	85.0	316.25	286.39	897.8	1184.2	0.017613	5.17
	80.3	95.0	324.12	294.56	891.7	1186.2	0.017696	4.65
	90.3	105.0	331.36	302.10	886.0	1188.1	0.017775	4.23
	100.0	114.7	337.90	308.80	880.0	1188.8	0.017850	3.88
	110.3	125.0	344.33	315.68	875.4	1191.1	0.017922	3.59
	120.3	135.0	350.21	321.85	870.6	1192.4	0.017991	3.33
	125.3	140.0	353.02	324.82	868.2	1193.0	0.018024	3.22
	130.3	145.0	355.75	327.70	865.8	1193.5	0.018057	3.11
	140.3	155.0	360.50	333.24	861.3	1194.6	0.018121	2.92
	150.3	165.0	365.99	338.53	857.1	1195.6	0.018183	2.75
	160.3	175.0	370.75	343.57	852.8	1196.5	0.018244	2.60
	180.3	195.0	379.67	353.10	844.9	1198.0	0.018360	2.34
	200.3	215.0	387.89	361.91	837.4	1199.3	0.018470	2.13
	225.3	240.0	397.37	372.12	828.5	1200.6	0.018602	1.92
	250.3	265.0	406.11	381.60	820.1	1201.7	0.018728	1.74
		300.0	417.33	393.84	809.0	1202.8	0.018896	1.54
		400.0	444.59	424.00	780.5	1204.5	0.019340	1.16
		450.0	456.28	437.20	767.4	1204.6	0.019547	1.03
		500.0	467.01	449.40	755.0	1204.4	0.019748	0.93
		600.0	486.21	471.60	731.6	1203.2	0.02013	0.77
	900.0	531.98	526.60	668.8	1195.4	0.02123	0.50	
	1200.0	567.22	571.70	611.7	1183.4	0.02232	0.36	
	1500.0	596.23	611.60	556.3	1167.9	0.02346	0.28	
	1700.0	613.15	636.60	519.6	1155.9	0.02428	0.24	
	2000.0	635.82	671.70	463.4	1135.1	0.02565	0.19	
	2500.0	668.13	730.60	360.5	1091.1	0.02860	0.13	
	2700.0	679.55	756.20	312.1	1068.3	0.03027	0.11	
	3206.2	705.40	902.70	0.0	902.7	0.05053	0.05	

# Steam Tables

Heat quantities and temperature-pressure relationships are useful in a wide range of trap application problems. This data is presented in Table 30-1 Properties of Saturated Steam.

## How the Tables Are Used

In addition to determining pressure-temperature relationships, you can compute the amount of steam that will be condensed by any heating unit of known btu output. Conversely, the tables can be used to determine btu output if steam condensing rate is known.

## Flash Steam

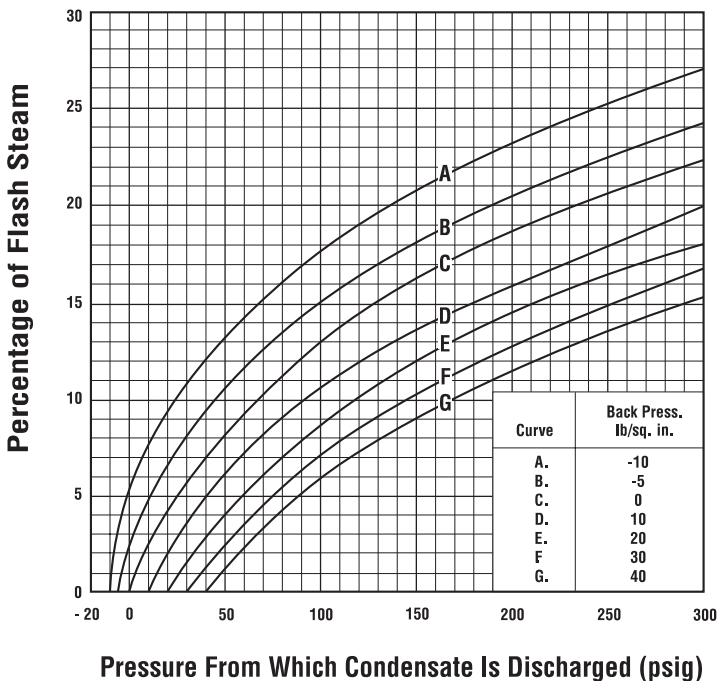
Flash steam is the steam formed when hot condensate under pressure is released to a lower pressure. The steam table (page 30) tells why it is formed. The amount that will be formed can be computed.

For example, condensate at steam temperature and under 100 psig pressure has a heat content of 308.8 btu's per pound (see Column 4 in steam table). If this condensate is discharged to atmospheric pressure (0 psig), its heat content instantly drops to 180 btu's per pound. The surplus of 128.8 btu's re-evaporates or flashes a portion of the condensate.

The percentage of the condensate that will flash to steam can be computed as follows: Divide the difference between the high and low heat contents (from Column 4) by the latent heat at the lower pressure and multiply by 100. Using the example above –  $308.8 - 180 = 128.8$ ;  $128.8 \div 970.3$  (latent heat at 0 psig from Column 5) = .133;  $.133 \times 100 = 13.3\%$ . Thus 13.3% of the condensate by weight will flash to steam.

For convenience Chart 32-1 shows the amount of flash steam that will be formed when discharging condensate to different pressures.

**Chart 32.1 Percentage of Flash Steam Formed When Discharging Condensate to Reduced Pressure**





**Table 33-1. Schedule 40 Pipe, Standard Dimensions**

Size (in)	Diameters		Nominal Thickness (in)	Circumference		Transverse Areas			Length of Pipe per sq ft		Length of Pipe Containing One Cubic Foot	Nominal Weight per foot		Number Threads per Inch of Screw
	External (in)	Approximate Internal (in)		External (in)	Internal (in)	External (sq in)	Internal (sq in)	Metal (sq in)	External Surface	Internal Surface		Plain Ends	Threaded and Coupled	
1/8	0.405	0.269	0.068	1.272	0.845	0.129	0.057	0.072	9.431	14.199	2533.775	0.244	0.245	27
1/4	0.540	0.364	0.088	1.696	1.114	0.229	0.104	0.125	7.073	10.496	1383.789	0.424	0.425	18
3/8	0.675	0.493	0.091	2.121	1.549	0.358	0.191	0.167	5.658	7.747	754.360	0.567	0.568	18
1/2	0.840	0.622	0.109	2.639	1.954	0.554	0.304	0.250	4.547	6.141	473.906	0.850	0.852	14
3/4	1.050	0.824	0.113	3.299	2.589	0.866	0.533	0.333	3.637	4.635	270.034	1.130	1.134	14
1	1.315	1.049	0.133	4.131	3.296	1.358	0.864	0.494	2.904	3.641	166.618	1.678	1.684	11fi
1-1/4	1.660	1.380	0.140	5.215	4.335	2.164	1.495	0.669	2.301	2.767	96.275	2.272	2.281	11fi
1-1/2	1.900	1.610	0.145	5.969	5.058	2.835	2.036	0.799	2.010	2.372	70.733	2.717	2.717	11fi
2	2.375	2.067	0.154	7.461	6.494	4.430	3.355	1.075	1.608	1.847	42.913	3.652	3.678	11fi
2-1/2	2.875	2.469	0.203	9.032	7.757	6.492	4.788	1.704	1.328	1.547	30.077	5.793	5.819	8
3	3.500	3.068	0.216	10.996	9.638	9.621	7.393	2.228	1.091	1.245	19.479	7.575	7.616	8
3-1/2	4.000	3.548	0.226	12.566	11.146	12.566	9.886	2.680	0.954	1.076	14.565	9.109	9.202	8
4	4.500	4.026	0.237	14.137	12.648	15.904	12.730	3.174	0.848	0.948	11.312	10.790	10.889	8
5	5.563	5.047	0.258	17.477	15.856	24.306	20.006	4.300	0.686	0.756	7.198	14.617	14.810	8
6	6.625	6.065	0.280	20.813	19.054	34.472	28.891	5.581	0.576	0.629	4.984	18.974	19.185	8
8	8.625	7.981	0.322	27.096	25.073	58.426	50.027	8.399	0.442	0.478	2.878	28.554	28.809	8
10	10.750	10.020	0.365	33.772	31.479	90.763	78.855	11.908	0.355	0.381	1.826	40.483	41.132	8
12	12.750	11.938	0.406	40.055	37.669	127.640	111.900	15.740	0.299	0.318	1.288	53.600	—	—
14	14.000	13.125	0.437	43.982	41.217	153.940	135.300	18.640	0.272	0.280	1.069	63.000	—	—
16	16.000	15.000	0.500	50.265	47.123	201.050	176.700	24.350	0.238	0.254	0.817	78.000	—	—
18	18.000	16.874	0.563	56.548	52.998	254.850	224.000	30.850	0.212	0.226	0.643	105.000	—	—
20	20.000	18.814	0.593	62.831	59.093	314.150	278.000	36.150	0.191	0.203	0.519	123.000	—	—
24	24.000	22.626	0.687	75.398	71.063	452.400	402.100	50.300	0.159	0.169	0.358	171.000	—	—

# Recommendations

## Survey

Armstrong International, Inc. recommends that you survey your steam traps on a regular schedule. This steam trap survey will provide information on your hook-ups, the opportunity to correct problem areas, reduce maintenance, and provide energy savings. For more information on how you can optimize your steam system contact your Armstrong Representative or Armstrong International, Inc. Ph. (269) 273-1415, Fax (269) 278-6555 or visit Armstrong's website at [armstronginternational.com](http://armstronginternational.com).

## **Products available from Armstrong International, Inc.**

### **Request Catalog 326**

Solution Source for Steam, Air and Hot Water Systems. 500 page manual which includes engineering guidelines along with information on Armstrong steam, air and water related products.

### **Request Bulletin 320**

CD-ROM of all material contained in 500-page manual described above coupled with Steam-A-Ware, Sizing and Selection Software.

### **Humidification**

Bulletin 596 = Humidification Solution Source

### **Refrigerated Purgers**

Bulletin 702 = Guide to Refrigeration Purging

Bulletin 705 = Multi-Point Purger

# Trap Application Assistance

Trap application assistance is a most important part of the complete trap service provided by Armstrong International, Inc. Armstrong Representatives are qualified by factory training and extensive experience to assist you in any trapping problem. Backing the Representatives are Armstrong trapping specialists who are available to assist with especially difficult or unusual requirements.

## Limited Warranty and Remedy

Armstrong International, Inc. ("Armstrong") warrants to the original user of those products supplied by it and used in the service and in the manner for which they are intended, that such products shall be free from defects in material and workmanship for a period of one (1) year from the date of installation, but not longer than 15 months from the date of shipment from the factory, [unless a Special Warranty Period applies, as listed below]. This warranty does not extend to any product that has been subject to misuse, neglect or alteration after shipment from the Armstrong factory. Except as may be expressly provided in a written agreement between Armstrong and the user, which is signed by both parties, Armstrong **DOES NOT MAKE ANY OTHER REPRESENTATIONS OR WARRANTIES, EXPRESS OR IMPLIED, INCLUDING, BUT NOT LIMITED TO, ANY IMPLIED WARRANTY OF MERCHANTABILITY OR ANY IMPLIED WARRANTY OF FITNESS FOR A PARTICULAR PURPOSE.**

The sole and exclusive remedy with respect to the above limited warranty or with respect to any other claim relating to the products or to defects or any condition or use of the products supplied by Armstrong, however caused, and whether such claim is based upon warranty, contract, negligence, strict liability, or any other basis or theory, is limited to Armstrong's repair or replacement of the part or product, excluding any labor or any other cost to remove or install said part or product, or at Armstrong's option, to repayment of the purchase price. As a condition of enforcing any rights or remedies relating to Armstrong products, notice of any warranty or other claim relating to the products must be given in writing to Armstrong: (i) within 30 days of last day of the applicable warranty period, or (ii) within 30 days of the date of the manifestation of the condition or occurrence giving rise to the claim, whichever is earlier. **IN NO EVENT SHALL ARMSTRONG BE LIABLE FOR SPECIAL, DIRECT, INDIRECT, INCIDENTAL OR CONSEQUENTIAL DAMAGES, INCLUDING, BUT NOT LIMITED TO, LOSS OF USE OR PROFITS OR INTERRUPTION OF BUSINESS.** The Limited Warranty and Remedy terms herein apply notwithstanding any contrary terms in any purchase order or form submitted or issued by any user, purchaser, or third party and all such contrary terms shall be deemed rejected by Armstrong.

Special Warranty Periods are as follows:

**Stainless Steel Products Series 1000, 1800, 2000** — Five (5) years after installation, but not longer than 30 months after shipment from Armstrong's factory.

© 2013 Armstrong International, Inc.



**Armstrong**<sup>®</sup>

Armstrong Steam and Condensate Group

816 Maple Street, Three Rivers, Michigan 49093 – USA

Phone: (269) 273-1415 FAX: (269) 278-6555